

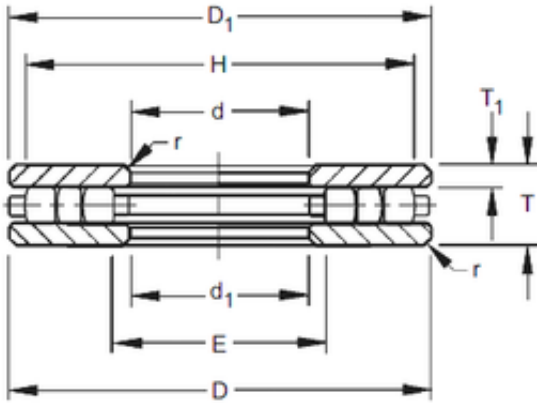

30TP108 Timken Tapered Roller Bearings

Bearing No. 30TP108



Size	76.2x203.2x34.925 mm
Bore Diameter	76,2 mm
Outer Diameter	203,2 mm
Width	34,925 mm
d	76,2 mm
D	203,2 mm
T	34,925 mm
r max	1,6 mm
T1	9,52 mm
d1	77,79 mm
D1	201,61 mm
E	90,5 mm
H	188,9 mm

30TP108 Bearing 2D drawings and 3D CAD models